

BABBS2

Bamboo Bar Stool Set

Max Weight Capacity 300 lbs



READ ALL INSTRUCTIONS AND WARNINGS BEFORE USING THIS PRODUCT.

STOP! DO NOT RETURN THIS PRODUCT TO THE RETAILER.

Questions? Problems? CONTACT CUSTOMER SERVICE.

If you experience a problem or need parts for this product, visit our website <http://www.buffalotools.com> or call our customer help line at **1-888-287-6981, Monday-Friday, 8 AM - 4 PM Central Time**. A copy of the sales receipt is required.

NOTE

Bamboo is not a wood but actually a woody variety of grass. Although it is a grass, the thick bamboo poles are two to three times as strong as wood. However, it will fade in color and can sometimes crack. These are the natural properties of Bamboo.

BEFORE USE, ALWAYS INSPECT THE STOOLS AND BAR UNIT FOR ANY CRACKS. DO NOT USE IF ANY COMPONENT IS DAMAGED AND MAY CAUSE HARM.

BAMBOO SHOULD RETAIN ITS STRENGTH FOR MANY YEARS. HOWEVER, WHEN STORED OUTDOORS, IT WILL AGE NATURALLY FROM A LIGHT TAN TO A SILVERY GRAY. YOU MAY ALLOW IT TO AGE NATURALLY OR APPLY UV-RESISTANT VARNISH AT LEAST ONCE A YEAR. TIES CAN BE REPLACED AS NEEDED.

When used outdoors, place on a dry surface such as concrete or decking, and not in wet areas such as grass. Cover during inclement weather. Mild household cleaning products can be used for cleaning.

ASSEMBLY

COMMON SENSE AND CAUTION ARE FACTORS WHICH CANNOT BE BUILT INTO ANY PRODUCT. THESE FACTORS MUST BE SUPPLIED BY THE OPERATOR.

On initial assembly, do not tighten screws completely until assembly is completed.

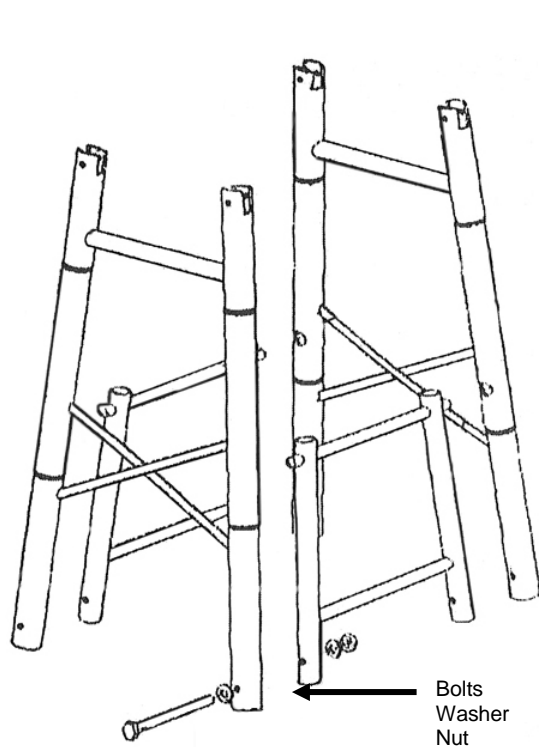

Figure 7
Place the Leg Supports (#12) between the Legs so that the post on the support faces the hole on a corresponding leg. Attach Bolts at the bottom of each leg.

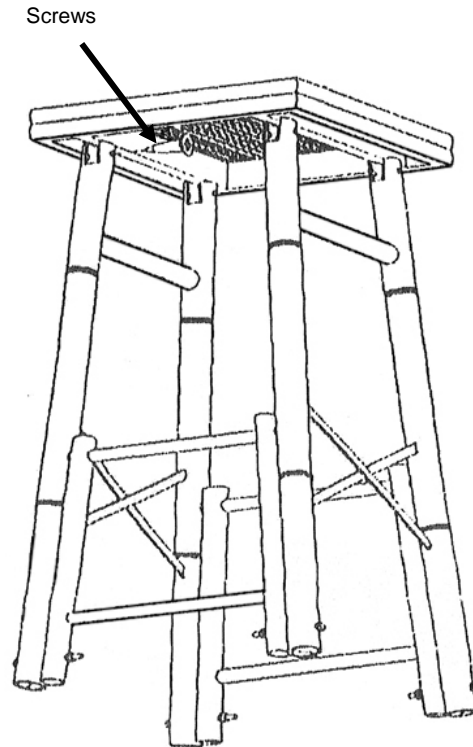









Figure 8
Place the legs so that the opening in the top of the legs straddles the Support Beam on the bottom side of the Seat. NOTE: Make sure the holes on the legs face each other. When both legs and their supports are in place, secure the legs to the Seat using 4 screws.

AFTER ASSEMBLY, CHECK THE NUTS AND BOLTS ON A REGULAR BASIS TO MAKE SURE THEY ARE TIGHT.

PARTS DIAGRAM

| | | | | | | |
|---|---|---|---|--|---|---|
|  |  |  |  |  |  |  |
| A | B | C | D | E | F | G |
| 1 PC | 2 PCS | 2 PCS | 4 PCS | 4 PCS | 8 PCS | 4 PCS |

(BABBS2 201208)